

# OMRON



## OMRON Oxygen Concentrator Y-506W Instruction manual

\*Thank you for purchasing the OMRON oxygen concentrator.

In order to use the device safely, please read the complete manual carefully before using it for the first time.  
Keep this instruction manual in a convenient place for future reference.



# CONTENT

I . Intended use .....	01
II . Special warning .....	01
III. Instructions to use .....	01
IV. Safety instructions .....	01
V . Product introduction.....	03
VI. Product use environment and normal working conditions .....	03
VII. Transportation and storage conditions .....	03
VIII. The scope of application of the product .....	03
IX. Product features .....	04
X . Know your device .....	05
XI. Operation steps .....	10
XII. Maintenance instructions .....	12
XIII. Schematic diagram of gas circuit and electric circuit .....	14
XIV. Troubleshooting .....	15
XV. Component spare parts and accessories .....	17
XVI. Environmental information .....	18
XVII. Warning .....	19
XVIII. Electromagnetic compatibility part description .....	19

# I . INTENDED USE

Oxygen inhalation in the general home and relief of respiratory disease.

Oxygen in the air is concentrated to support the respiration of patients living at home with respiratory problems, mainly chronic obstructive pulmonary disease, etc.

# II . SPECIAL WARNING

1. This equipment is to be used as an oxygen supplement and is not intended to be life supporting or life sustaining. In order to prevent power failure or possible failures of the oxygen concentrator, those in urgent need of oxygen and critically ill patients must be equipped with other oxygen supply devices (such as: oxygen cylinders, oxygen bags, etc.) as backup.
2. Seek medical advice before using this device.
3. It is mainly designed for general household use. It is not suitable to use in public places and health care places.

# III. INSTRUCTIONS TO USE













1. The device and its components need to be carefully maintained to ensure the product life. Therefore, the device must be carefully maintained based on the prescribed maintenance period, especially in harsh working conditions.
2. If there is a quality problem, the customer shall not disassemble and repair it privately. If abnormal phenomena such as the alarm is found, please contact the customer support for consultation (see the back cover).





# IV. SAFETY INSTRUCTIONS

1. Open flames or smoking during oxygen therapy are dangerous and may result in fire, facial burns, or death. Do not allow smoking or open flames within 2m of the device or any oxygen carrying accessories, such as an attached cannula.
2. Do not use oil, grease or petroleum-based products on or near the device as the use of such products may damage the electronic components of the device.
3. For proper operation, the device requires unobstructed ventilation. The device should be located as to avoid pollutants or flames.
4. Do not plug or unplug the power cord when there is water on your hand. Otherwise it may cause electric shock.
5. Do not use alcohol, solvents, polishes or any oily substances on the device. Otherwise, the output oxygen may be contaminated, causing injury or physical discomfort.
6. When placing the oxygen concentrator, please keep a distance of 16cm from walls, curtains or other objects, otherwise it may affect the air exchange of the air exhaustion of oxygen concentrator.
7. The device should not be used adjacent to or stacked with other equipment because it could result in

improper operation .

8. Do not use the oxygen concentrator if either the plug or power cord is damaged . Do not use extension cords or electrical adapters.
9. Do not attempt to clean the concentrator while it is plugged into an electrical outlet.
10. The oxygen concentrator regularly emits a "ta..pu" exhaust sound when the oxygen concentrator is operating (about 7 seconds).
11. The manufacturer recommends that the oxygen concentrator runs for no less than 30 minutes each time when turned on. Do not turn on and off the oxygen concentrator frequently. It is suggested to turn on/ turn off after 3 to 5 minutes each time, to avoid affecting the life of the compressor.
12. The use of accessories or service equipment not specified for use with the device may impair its performance.
13. Please do not adjust the flow rate above 5L/min, otherwise the oxygen purity may not reach more than 90%.
14. When the oxygen purity is abnormal, the user should contact the customer support for consultation (see the back cover).
15. If you begin to feel ill or are experiencing discomfort while using the oxygen concentrator, please go to the doctor immediately.
16. When the user is a child or a person with limited mobility, the device needs to be used under the supervision of the custodian.
17. If you have plan not to use the oxygen concentrator for several days, please clean and dry the humidification bottle for storage.
18. Molecular sieve is a consumable, it will absorb moisture from the air during use and storage, and its performance will decay, resulting in a decrease in oxygen purity. Before the first use, if the oxygen purity is lower than 90%, please contact the customer support for consultation (see the back cover).
19. Do not leave the nasal oxygen cannula on bed covering or chair cushion, if the oxygen concentrator is turned on but not in use, the oxygen will make the materials flammable. Turn the device off when it is not in use.
20. The meaning of symbols.

Symbol	Meaning	Symbol	Meaning	Symbol	Meaning
	Alternating current		Indicates a warning or note		Temperature limit
	Class II equipment		Stacking layer limit		Humidity limitation
	No smoking		Manufacturer		Atmospheric pressure limitation
	Keep dry		This way up		Consult instructions for use

Symbol	Meaning	Symbol	Meaning	Symbol	Meaning
I	On (main power)		Off (main power)		Type BF applied part
IPX0	No protection		Fragile items		No open flames

## V. PRODUCT INTRODUCTION

The Y-506W oxygen concentrator uses the principle of Pressure Swing Adsorption to separate the oxygen in the air from nitrogen and other gases. At room temperature, the oxygen which meets medical standards can be continuously separated from the air when the power is turned on. Product composition: Main unit, Power cord, Instruction manual, Nasal oxygen cannula, Filter sponge, Disposable kit for nebulization, Fuse, Humidification bottle, Humidification tube, Screwdriver, Warranty card, Instructions for unpacking.

## VI. PRODUCT USE ENVIRONMENT AND NORMAL WORKING CONDITIONS

1. Power requirements: AC220V  $\pm$  22V, 50Hz  $\pm$  1Hz
2. Ambient temperature: 5°C~40°C
3. Relative humidity:  $\leq$ 80%
4. Atmospheric pressure: 860hPa~1060hPa
5. Warm-up time: 30min

 Note: If the storage or transportation temperature was lower than 5°C, it is recommended to place the device in a normal working condition for more than 4 hours before using.

## VII. TRANSPORTATION AND STORAGE CONDITIONS

1. Ambient temperature range: -20°C~+55°C
2. Relative humidity range:  $\leq$ 93%, and no condensation
3. Atmospheric pressure range: 700hPa~1060hPa

 Note: The oxygen concentrator should be stored in an environment like this: No strong sunlight, no corrosive odor, well ventilated, and clean. Avoid violent vibration, inverted or horizontal placement during transportation.

## VIII. THE SCOPE OF APPLICATION OF THE PRODUCT

Using air as the raw material, the molecular sieve pressure adsorption process is used to produce oxygen (Oxygen purity 90% to 96%). Could be used for oxygen therapy or liquid nebulization treatment.

## IX. PRODUCT FEATURES

- ◆ Accumulative timing function: The total working time of the oxygen concentrator is displayed on the display screen.
- ◆ Single-time timing function: The single-time working time is displayed on the display screen, understand the running time of the equipment better.
- ◆ Power failure alarm function: Continuous buzz to remind users.
- ◆ The compressor is equipped with an over-pressure safety valve and a heat suppressor to ensure the safety of the compressor and the whole device better.
- ◆ Timing function: Max 8h (Interval time 10min adjustable).
- ◆ Voice function: There is a voice each time when pressing the function buttons.
- ◆ Real-time oxygen purity monitoring function: Can help to monitor oxygen purity better and understand the use condition of patients: oxygen purity  $\geq 82\%$ , only the green light of the operation indicator is on;  $50\% \leq$  oxygen purity  $< 82\%$ , yellow light is on; oxygen purity  $< 50\%$ , the red light is on (display E4), and 3 sound instructions are issued, the device does not stop.
- ◆ Fault detection function (including compressor fault, low oxygen purity fault detection). The display shows the fault code (E1, E2, E4).

### Main technical indicators of oxygen concentrator

Under the maximum recommended flow rate, apply a back pressure of 7kPa, and the flow rate change should be within the range of 5L/min  $\pm 10\%$ .

When the oxygen flow is 0.5~5L/min, the oxygen purity is  $\geq 90\%$  (V/V) (reach the specified purity level within 30 minutes of the initial start).

Maximum recommended oxygen flow: 5L/min

The flow rate when the nominal outlet pressure is 0~7kPa: 0.5~5L/min

When the nominal outlet pressure is zero, the function graph of oxygen purity and oxygen flow (see the figure at right):

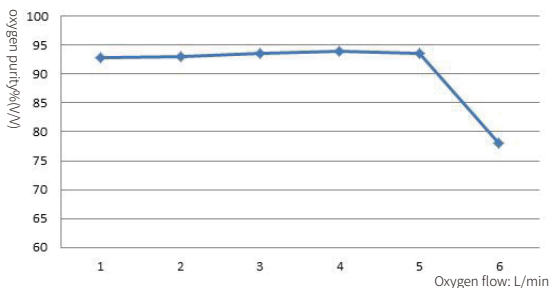

Maximum outlet pressure:	Under the rated oxygen flow, 20kPa-70kPa
Compressor relief valve release pressure:	250kPa $\pm$ 50kPa
Maximum atomization rate:	$\geq$ 0.2mL/min
Oxygen concentrator noise:	$\leq$ 60dB(A)
Rated input power:	480VA
Electrical classification:	Class II equipment, type BF applied part
Operation mode:	Continuous operation
Degree of protection against ingress of liquid:	IPX0
Net weight:	21.3kg
Dimensions:	350(L)mm $\times$ 330(W)mm $\times$ 660(H)mm
Altitude:	<1828 meters, the device operates normally; >1828 meters and <4000 meters, the efficiency will be less than 90%
Device type:	Non-AP/APG device (The device should not be used with flammable anesthetic gas mixed with air or flammable anesthetic gas mixed with oxygen or nitrous oxide)
Durable period (Service life):	5 years (except fragile parts and consumables)
Fragile parts and consumables:	Fuses, filter sponge, air filter, humidification bottle, humidification tube, nasal oxygen cannula, disposable kit for nebulization and casters.

## X. KNOW YOUR DEVICE



Front view of the whole device



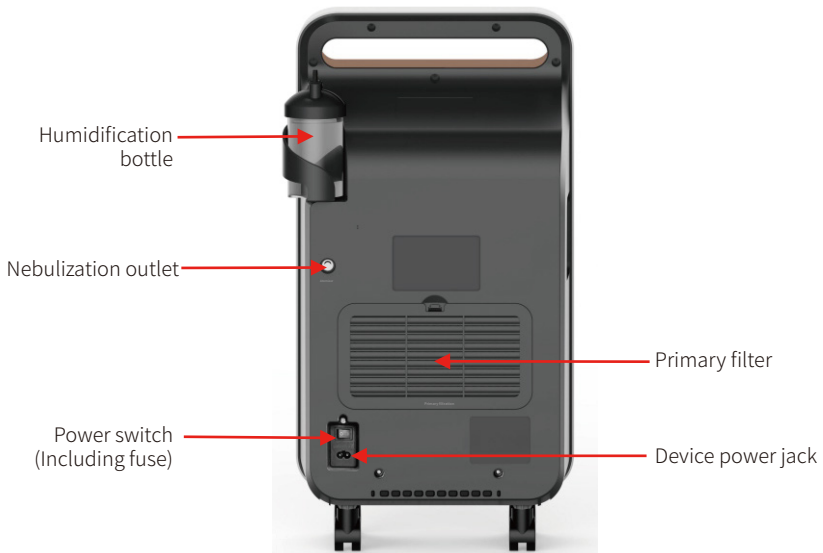

**Rear view of the whole device**



**Side view of the whole device**

## 1. Operation panel:

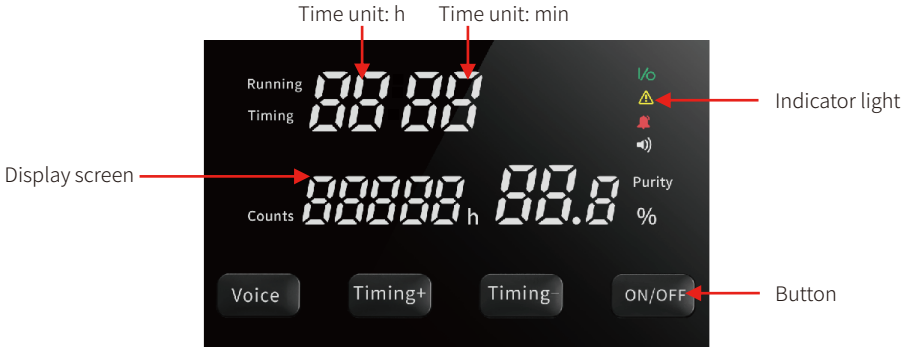

### Display screen:

It can display the device's cumulative running time, single-time running time, adjustable timing time, fault code, oxygen purity.

- After power on, the screen displays the accumulated time. The running time starts to count, and the oxygen purity is monitored and displayed in real time.
- Each time you press the "ON/OFF" button, the single-time running time is automatically cleared, and the cumulative running time automatically accumulates.
- "Timing +" button, "Timing -" button: Press the "Timing +" button to switch to time accounting, and the countdown will start after the time is confirmed. Press the "Timing -" button can reduce the accounting time. The device will stop oxygen producing and enter the standby state after the timing is completed; Set the timing for 8 hours and press the "Timing +" button again to enter the continuous oxygen therapy mode, then the screen will display the running time. When the timing time is  $\leq 10\text{min}$ , press the "Timing -" button once to resume continuous oxygen therapy mode and the screen will display the running time.

### Indicator light:

- |  |  |
|--|--|
|  Green light (running) |  Yellow light (low oxygen purity) |
|  Red light (fault)     |  White light (voice)              |

### Their roles are as follows:

- Green light is on: The green light is on after the power is turned on indicating the oxygen concentrator is in operation.
- Yellow light is on:  $50\% \leq \text{oxygen purity} < 82\%$ .
- The red light is on: Oxygen purity  $< 50\%$  or the compressor meets fault.
- White light is on: The voice function is on.

## Button:

Voice: Control device voice function on or off;

Timing +: Increase the timing time. Each time you press it, increase 10 mins;

Timing -: Decrease the timing time. Each time you press it, decrease 10 mins;

ON/OFF: Control device to start or to stop oxygen production;

The user needs to inhale oxygen regularly, and adjust the timing time through the "Timing +" and "Timing -" keys. After setting the timing, the device will automatically supply oxygen at the set time, and the device will enter the standby state after completing the oxygen supply. If you don't need timing, you can press the "Timing -" button continuously until the device is back into continuous oxygen therapy mode.

## 2. Oxygen outlet:

Give off the oxygen produced by the device.

## 3. Flowmeter:

Flow rate: 0.5L/min~5L/min

## 4. Flow adjustment knob:

Adjustment method: After the oxygen concentrator is started, you can turn the flow adjustment knob. Clockwise to increase, counterclockwise to decrease.

The corresponding scale line in the middle of the float also shows the current operating flow.

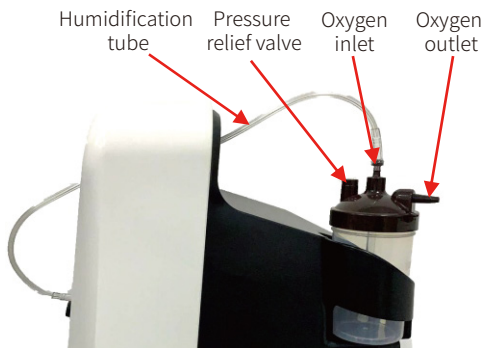

## 5. Humidification bottle (model: S-5):

Add distilled water or cold boiled water into the humidification bottle to moisturize the oxygen to prevent dry oxygen from irritating the throat and nasal mucosa.

The added amount of water should be below the highest water level.

The oxygen inlet of the humidification bottle and oxygen outlet of the device are connected through a humidification tube.

If the oxygen outlet of the humidification bottle was blocked, the pressure relief valve of the humidification bottle will operate by itself. At this time, oxygen will be ejected from the pressure relief valve but not the oxygen outlet.

## 6. Fuse holder:

When the electric current of the device is overload, the fuse will automatically cut off the circuit to protect the device and the user. Please replace a new fuse.

## 7. Power switch:

"| " is to turn on, "○" is to turn off.



Power switch

Fuse Holder

Device power jack

## 8. Device power jack:

The power cord plug is inserted into the network power socket, and the power cord connector is inserted into the device power jack. Then the device can get power supply.

## 9. Primary filter:

Contains filter sponge for air filtration.

## 10. Secondary filter:

Contains air filter for air filtration.

## 11. Nebulization outlet:

When the user needs nebulization treatment, unscrew the plug of the nebulization outlet and connect the outlet with the disposable kit for nebulization to use the nebulization function. Please refer to [nebulization function description] in P11 [Operation steps].

# XI. OPERATION STEPS

1. Add water to the humidification bottle: Take out the humidification bottle, unscrew the lid, pour distilled water or cold boiled water into the cup, between the maximum and minimum. Then tighten the lid, and put it back to its original position.  
2 Take out the humidification tube (see the figure for details), then connect the oxygen outlet of the device and the oxygen inlet of the humidification bottle.

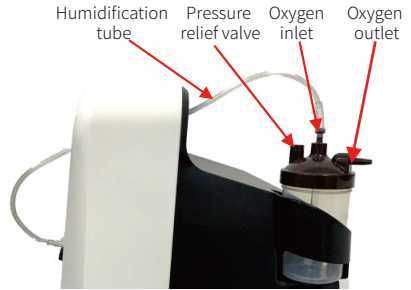

3. Turn on the power: Insert the power cord connector into device power jack; Plug the other end of the power cord into the indoor power socket, then turn on the power switch, press the ON/OFF button to start oxygen production.  
4. Adjust the flow adjustment knob as needed.  
5. Insert the inlet end of the nasal oxygen cannula into the outlet of the humidification bottle, and then put the nasal oxygen cannula on the user's ears, inserting the nasal congestion in the user's nose (as shown in the figures below). Please follow the doctor's advice for the time and flow of oxygen inhalation.

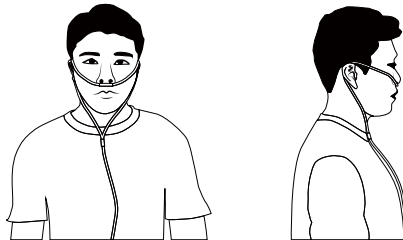

**Schematic figures of nasal oxygen cannula wearing**

6. When the oxygen therapy is finished, press the "ON/OFF" button on the display, and then turn off the power switch. If don't use the device for a long time, please unplug the power cord.  
7. If you need to inhale oxygen and use time function, please refer to "1. Operation panel: button" in "Know Your Device"P7 for details.  
8. Oxygen purity prompt function:  
The oxygen purity will reach a steady state after 30 minutes of starting up.  
a) When  $50\% \leq \text{oxygen purity} < 82\%$ , the yellow light is on.  
b) Oxygen purity  $< 50\%$ , the fault red light is on, and three voice instructions are issued, the fault code "E4" and the running time are displayed alternately.

9. If a sudden power failure occurs during the operation of the device with an alarm sound, please check whether the power connection part or the external power supply is in good condition.

10. Nebulization function description:

1) Unscrew the plug of the nebulization outlet and connect it to the disposable kit for nebulization to start nebulization. When the user needs to use the nebulization function, please refer to the "Schematic diagram of the disposable kit for nebulization" to install a disposable nebulization kit.

2) When the nebulization function is used, the oxygen purity will be reduced and the device may alarm, and the alarm will be automatically released when the oxygen flow is reduced. It is not a malfunction.

3) Operation steps:

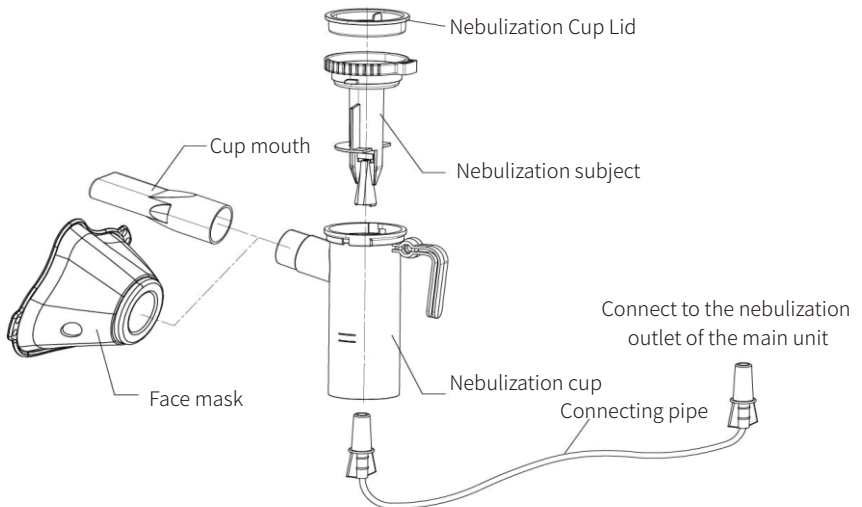

- a. Add an appropriate amount of liquid medicine into the nebulization cup.
- b. Unscrew the plug of the nebulization outlet in counterclockwise direction.
- c. Connect the two ports of the connecting pipe to the nebulization cup and the nebulization outlet of the main unit respectively.
- d. Turn on the power switch of the main unit and press ON/OFF button to start nebulization therapy.
- e. After therapy, screw the nebulization plug clockwise into the nebulization outlet of the main unit and tighten it.



**Schematic figures of the disposable kit for nebulization**

⚠ Note: When using the nebulization function, please follow the doctor's advice for the type, dosage and usage of the liquid medicine. Especially patients with coma or thick sputum, otherwise it may cause bad symptoms.

## 11. Alarm and hint:

Symbol	State	Status Indicator	Alarm sound	Alarm sound pressure	Alarm status priority	State
	50%≤oxygen purity<82%	Yellow light on	None	Not applicable	Low priority	Run
	Compressor failure alarm: 1. The compressor circuit is open (display E1) 2. The Compressor short circuit (display E2)	Red light on	Long ring	≥55db(A)	Low priority	Shutdown
	Power failure alarm	Red light on	Long ring	≥55db(A)	Low priority	Shutdown

- ◆ After the oxygen concentrator has been running for 5 minutes, the oxygen purity monitor starts to work normally.
- ◆ After an alarm occurs, you can turn off the alarm by pressing the "ON/OFF" button of the oxygen concentrator.
- ◆ When the oxygen purity is less than 50%, the product will give out a low oxygen purity prompt, the display shows "E4", the red light is on, and the sound indicates.
- ◆ Under normal conditions, if the product has a low oxygen purity alarm or prompt, please turn it off immediately, use spare oxygen, and immediately contact the OMRON customer support for consultation (see the back cover) .

## XII. MAINTENANCE INSTRUCTIONS

**Warning: Before maintaining the oxygen concentrator, firstly cut off the power supply to avoid electric shock. Do not disassemble the device.**

### 1. Outer shell

The outside of the device should be cleaned and disinfected at least once a month. If there is pollution on the outside , please clean and disinfect immediately. Before cleaning the oxygen concentrator, you must turn off the power of the device and disconnect the AC power. Wipe the surface of the oxygen concentrator and the cable with a clean, soft, slightly damp, lint-free cloth or sponge. If necessary, wipe it with a small amount of non-corrosive diluted detergent. Wipe the device dry with a clean, dry, soft cloth, and do not allow liquid to penetrate into the cracks of the shell.

During the cleaning process, you only need to wipe the outer periphery of the connecting socket, not the inside. The cleaning agent should be removed after cleaning. Non-corrosive cleaners should be used to clean the outer surface of the device and the display screen. Most cleaners must be diluted before use.

### 2. Filters

The cleaning and the replacement of the filters protect the compressor and molecular sieve, and

extend the oxygen concentrator life. Please clean or replace in time.

**Primary filter:** Remove the cover of the primary filter, take out the filter sponge to clean it once every half a month. Use light detergent firstly, rinse with clean water, and then install it after it is completely dry.

**Secondary filter:** After 3000 hours of use, or the filter becomes dirty, please replace it with a new one. Replacement method: Unscrew the fixing screws of the secondary filter cover, remove the cover, pull out the old filter, replace a new one, and reinstall the cover.

For consulting about filter, please contact customer support (see the back cover).



Filter sponge

Primary filter



Air filter

Secondary filter



**Warning: Do not operate the oxygen concentrator when the filters are not installed or when they are damp, because this will cause permanent damage to the device. (The air filter cannot be cleaned).**

### 3. Humidification bottle

The oxygen concentrator is equipped with a humidification bottle, and it is recommended to clean it each time.

The cleaning work is carried out as follows.

- a) Wash the humidification bottle with hot water with dishwashing detergent and rinse it with clean water.
- b) Mix white vinegar and hot water in a ratio of 1:3, and put the humidification bottle in the mixed solution for 30 minutes.
- c) Rinse the humidification bottle thoroughly with hot water, and dry it for later use.

### 4. Disposable kit for nebulization

The disposable kit for nebulization recommended by the manufacturer is a disposable airflow sprayer. In order to avoid the infection, please do not reuse or share with others.

### 5. Fuse

When it is suspected or confirmed that the fuse is blown, please remove it for inspection and replacement.

The fuse holder is under the power switch of the main unit. Use a screwdriver or other sharp object to



pry out the fuse holder (Figure 1 and Figure 2). After replacing the new fuse (Figure 3), reinstall the fuse holder (Figure 4).



Figure 1



Figure 2



Figure 3



Figure 4

### XIII. SCHEMATIC DIAGRAM OF GAS CIRCUIT AND ELECTRIC CIRCUIT

#### 1. Schematic diagram of gas circuit

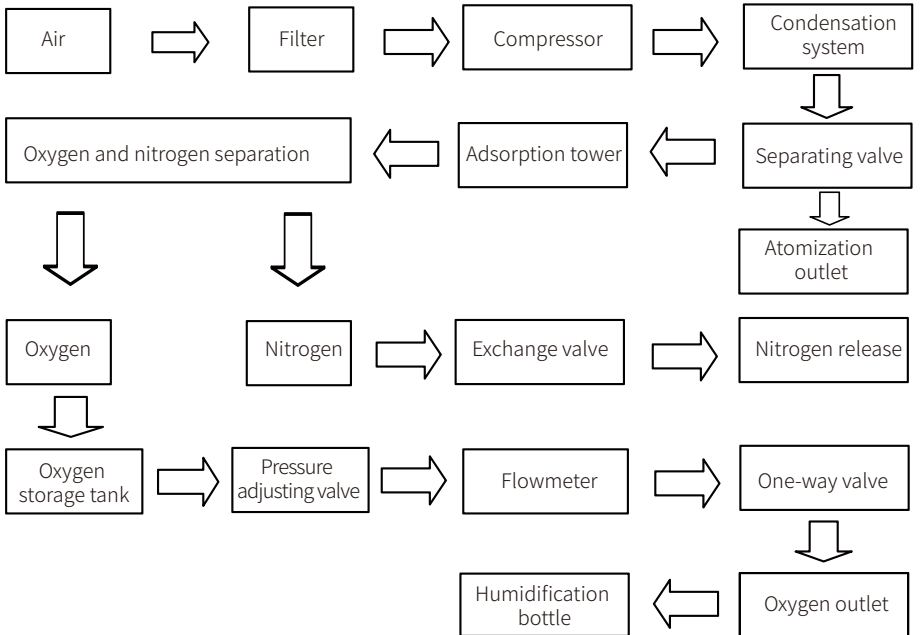

## 2. Schematic diagram of electric circuit

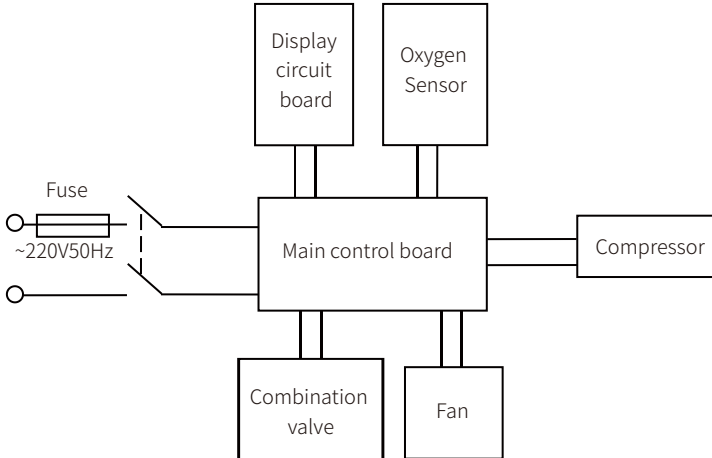

**Note: If maintenance needed, please contact the Omron customer support (see the back cover).**

## XIV. TROUBLESHOOTING

No.	Failure phenomenon	Possible reason	Elimination method
1	During operation of the device, the red light suddenly flashes, accompanied by a continuous beeping sound, and the device stops running.	1) Poor contact between the power cord plug and the socket.	1) Insert the power cord plug firmly into the socket.
		2) There is no power output from the socket.	2) Move to a socket with power output.
		3) Turned off the power switch directly but didn't press the ON/OFF button of the operation panel as required.	3) Turn on the power switch and restart the device.
		4) The fuse of the network power supply is blown out.	4) Replace the fuse. Firstly cut off the power supply and carry out by professional maintenance personnel.
		5) If the oxygen concentrator still does not work, please contact the customer support for consultation (see the back cover).	
2	After the device is turned on, the sound is normal the flow rate can be adjusted normally, but there is little or no oxygen coming out.	1) The humidification bottle and the device are not firmly sealed so the oxygen leaks.	1) Check the sealing ring on the inlet and outlet of the humidification bottle and reinstall it.
		2) The humidification bottle's water inlet is not firmly sealed in place so the oxygen leaks.	2) Check the rubber stopper of the humidification bottle and reinstall it.
		3) If the phenomenon continues, please contact the customer support for consultation (see the back cover).	

3	The oxygen concentrator does not work, the red light is on, and the display shows "E1".	1) The compressor circuit is open.	1) Stop using the device immediately, please contact the customer support for consultation (see the back cover).
4	The oxygen concentrator does not work, the red light is on, and the display shows "E2".	1) The compressor circuit is short.	1) Stop using the device immediately, please contact the customer support for consultation (see the back cover).
5	The oxygen concentrator is working but the yellow light is on.	1) 50% ≤ oxygen purity <82%.	1) Clean or replace the filter.
		2) The oxygen flow exceeds 5L/min.	2) Re-adjust the oxygen flow according to the doctor's advice that not exceed the MAX flow 5L/min.
		3) If the phenomenon continues, you can continue to use the device, but please contact the customer support for consultation (see the back cover).	
6	The oxygen concentrator is working, but the red light is on, and the display shows "E4".	1) oxygen purity <50%.	1) Clean or replace the filter.
		2) The oxygen flow exceeds 5L/min.	2) Re-adjust the oxygen flow according to the doctor's advice that not exceed the MAX flow 5L/min.
		3) If the phenomenon continues, please contact the customer support for consultation (see the back cover).	
7	The inside of the nasal oxygen cannula has a lot of fog or water droplets (the method of removing the fog or water droplets: after starting up, connect the cannula to the oxygen outlet, and use your fingers to open and close the cannula port repeatedly to discharge the water droplets).	1) There is no safe ventilation around the device, resulting in working temperature too high.	1) Make sure that the device is at least 20cm away from the wall or other blockages and heaters.
		2) The temperature of the water added in the humidification bottle is too high.	2) Add cold water into the bottle.
		3) Too much water is added to the humidification bottle.	3) Add water below the highest water level.
		4) Sudden shutdown during oxygen inhalation.	4) Immediately stop oxygen inhalation and restart the device to discharge water vapor.
		5) The nasal oxygen cannula is collapsed.	5) Straighten out the nasal oxygen cannula.
		6) The internal fan is not working properly., resulting in high working temperature.	6) Replace the fan. Firstly cut off the power supply and carry out by professional maintenance personnel.
		7) If the phenomenon continues, stop using the device, please contact the customer support immediately for consultation (see the back cover).	

8	When the nebulization function is working, the amount of nebulization fog is little or the medicine liquid can not be nebulized.	1) The installation of the disposable kit for nebulization is not in place or installed incorrectly.	1) Install correctly according to the installation method.
		2) The disposable kit has been deformed during cleaning and disinfection.	2) Replace the disposable kit.
		3) The cup mouth of the nebulization cup is blocked.	3) Clean or replace the nebulization cup.
		4) Excessive addition of liquid medicine.	4) Add an appropriate amount of liquid medicine into the cup according to the doctor's advice, and do not exceed the maximum scale line.
		5) If the phenomenon continues, stop using the device, please contact the customer support immediately for consultation (see the back cover).	



**Note: If the oxygen concentrator has other faults that cannot be eliminated, please contact the customer support (see the back cover).**

## XV. COMPONENT SPARE PARTS AND ACCESSORIES

Product description	Amount
Power cord	1 Pc
Instruction manual	1 Pc
Nasal oxygen cannula	1 Pc
Filter sponge	1 Pc
Disposable kit for nebulization	1 Set
Fuse(T5AL250V)	2 Pcs
Humidification bottle(S-5)	1 Pc
Humidification tube	1 Pc
Screwdriver	1 Pc
Warranty card	1 Pc
Instructions for unpacking	1 Pc

Purchasable accessories

Product description	Model	Amount	Shelf life
Nasal Oxygen Cannula	MB01-L-2.0	1 Pc	3 years
Nebulizer Maske For Single Use	MW01-L-2.0	1 Set	3 years

Note: The component spare parts and accessories need to follow "The required transportation and storage conditions."(Please refer to P3). Otherwise the shelf life might be inaccurate.

If you need other accessories, please contact the Omron customer support (see the back cover).

# XVI. ENVIRONMENTAL INFORMATION

The related wastes, residues and accessories of this product may have an impact on the environment, and their disposal should comply with the corresponding national laws and regulations. It is recommended to consult the environmental protection department or the Omron customer support when dealing with the corresponding waste and residue generated from this device.

We reserve the right to change the technology and appearance of this product. If there is any change without notice, please forgive!

## **XVII. WARNING**



**Please do not place the oxygen concentrator near a strong magnetic field or electromagnetic interference source.**

## **XVIII. ELECTROMAGNETIC COMPATIBILITY PART DESCRIPTION**

This product (Hereinafter "This Product" refers to the oxygen concentrator Y-506W) complies with IEC 60601-1-2 "Electromagnetic Compatibility of Medical Devices." The following examples should be followed:

- 1.This product should be used according to the electromagnetic compatibility information provided in the manual;
2. Portable and mobile radio frequency communication equipment may affect the normal operation of this product;
3. The maximum length of the power cord of this product is 2m;
4. In addition to the accessories and power cord that come with this product, the use of accessories and cables other than those specified may result in an increase in equipment emission or a decrease in immunity;
- 5.The basic performance of this product: It can continuously separate oxygen from the air;
- 6.This product should not be used close to or stacked with other equipment. If it must be used close to or stacked, it should be observed to verify that it can operate normally under the configuration used.

**Table 17.1**

<b>Guidance and Manufacturer's Declaration-Electromagnetic Emissions</b>		
The device is intended for use in the electromagnetic environment specified below.The customer or the user of the device should assure that the device is used in such an environment.		
Emissions Test	Compliance	Electromagnetic Environment-Guidance
RF emissions CISPR 11	Group 1	The device uses RF energy only for its internal function. Therefore, its RF emissions are very low and are not likely to cause any interference in nearby electronic equipment.
RF emissions CISPR 11	Class B	The device is suitable for use in all establishments, including domestic establishments and those directly connected to the public low-voltage network that supplies buildings used for domestic purposes.
Harmonic Emissions IEC61000-3-2	Class A	
Voltage Fluctuations/Flicker Emissions IEC 61000-3-3	Complies	

**Table 17.2**

<b>Guidelines and Manufacturer's Declaration-Electromagnetic Immunity</b>			
The concentrator is intended for use in the electromagnetic environment specified below. The user of the concentrator should make sure it is used in such an environment.			
<b>Immunity Test</b>	<b>IEC 60601 Test Level</b>	<b>Compliance Level</b>	<b>Electromagnetic Environment-Guidance</b>
Electrostatic discharge (ESD) IEC 61000-4-2	±6kV contact ±8kV air	±6kV contact ±8kV air	Floors should be wood, concrete or ceramic tile. If floors are covered with synthetic material, the relative humidity should be at least 30%.
Electrical fast transient burst IEC 61000-4-4	±2kV for power supply lines ±1kV for input/output lines	±2kV for power supply lines ±1kV for input/output lines	Mains power quality should be that of a typical commercial or hospital environment.
Surge IEC 61000-4-5	±1 kV line(s) to line(s) ±2 kV line(s) to earth	±1 kV line(s) to line(s) ±2 kV line(s) to earth	Mains power quality should be that of a typical commercial or hospital environment.
Voltage dips, short interruptions and voltage variations on power supply input lines IEC 61000-4-11	<5% $U_T$ (>95% dip in $U_T$ ) for 0.5 cycle  40% $U_T$ (60% dip in $U_T$ ) for 5 cycles  70% $U_T$ (30% dip in $U_T$ ) for 25 cycles  <5% $U_T$ (>95% dip in $U_T$ ) for 5 sec	<5% $U_T$ (>95% dip in $U_T$ ) for 0.5 cycle  40% $U_T$ (60% dip in $U_T$ ) for 5 cycles  70% $U_T$ (30% dip in $U_T$ ) for 25 cycles  <5% $U_T$ (>95% dip in $U_T$ ) for 5 sec	Mains power quality should be that of a typical commercial or hospital environment. If the user of the [ME EQUIPMENT or ME SYSTEM] requires continued operation during power mains interruptions, it is recommended that the [ME EQUIPMENT or ME SYSTEM] be powered from an uninterrupted power supply or a battery.
Power frequency magnetic field (50Hz/60Hz) EC61000-4-8	3A/m	3A/m	Power frequency magnetic fields should be at levels characteristic of a typical location in a typical hospital or home environment.
Note: $U_T$ refers to the AC network voltage before the test voltage is applied.			



**Table 17.3**

<b>Guidelines and Manufacturer's Declaration-Electromagnetic Immunity</b>			
The concentrator is intended for use in the electromagnetic environment specified below. The user of the concentrator should make sure it is used in such an environment.			
Immunity Test	IEC 60601 Test Level	Compliance Level	Electromagnetic Environment--Guidance
<p>Conducted RF IEC 61000-4-6</p> <p>Radiated RF IEC 61000-4-3</p>	<p>3Vrms 150kHz to 80MHz</p> <p>3V/m 80MHz to 2.5GHz</p>	<p>3Vrms</p> <p>3V/m</p>	<p>Portable and mobile RF communications equipment should be used no closer to any part of the device, including cables, than the recommended separation distance calculated from the equation applicable to the frequency of the transmitter.</p> <p>Recommended separation distance:</p> $d = 1.2 \sqrt{P} \quad 150 \text{ kHz to } 80 \text{ MHz}$ $d = 1.2 \sqrt{P} \quad 80 \text{ MHz to } 800 \text{ MHz}$ $d = 2.3 \sqrt{P} \quad 800 \text{ MHz to } 2.5 \text{ GHz}$ <p>Where P is the maximum output power rating of the transmitter in watts (W) according to the transmitter manufacturer and d is the recommended separation distance in meters (m).</p> <p>Field strengths from fixed RF transmitters, as determined by an electromagnetic site survey <sup>a</sup>, should be less than the compliance level in each frequency range<sup>b</sup>.</p> <p>Interference may occur in the vicinity of equipment marked with the following symbol: </p>
<p>Note 1: At 80MHz and 800MHz, the higher frequency range applies.</p> <p>Note 2: These guidelines may not apply in all situations. Electromagnetic propagation is affected by absorption and reflection from structures, objects, and people.</p>			
<p>a) Field strength from fixed transmitters, such as base stations for radio(cellular/cordless)telephones and land mobile radios, amateur radio, AM and FM radio broadcast and TV broadcast cannot be predicted theoretically with accuracy To assess the electromagnetic environment due to fixed RF transmitters, an electromagnetic site survey should be considered. If the measured field strength in the location in which the concentrator is used exceeds the applicable RF compliance level above, the concentrator should be observed to verify normal operation. If abnormal performance is observed, additional measures may be necessary, such as re-orienting or relocating the device.</p> <p>b) Over the frequency range 150 KHZ to 80 MHZ, the field strengths should be less than 3V/m.</p>			

**Table 17.4**

**Recommended Separation Distances between Portable and Mobile RF Communications Equipment and This Device:**

This concentrator is intended for use in an electromagnetic environment in which radiated RF disturbances are controlled. The user of the concentrator can help prevent electromagnetic interference by maintaining a minimum distance between portable and mobile RF communications equipment(transmitters)and this concentrator as recommended below, according to the maximum output power of the communications equipment.

Rated Maximum Power Output of Transmitter(W)	Separation Distance According to Frequency of Transmitter(M)		
	150 kHz to 80 MHz $d = 1.2 \sqrt{P}$	80 MHz to 800 MHz $d = 1.2 \sqrt{P}$	800 MHz to 2.5 GHz $d = 2.3 \sqrt{P}$
0.01	0.12	0.12	0.23
0.1	0.38	0.38	0.73
1	1.2	1.2	2.3
10	3.8	3.8	7.3
100	12	12	23

For transmitters rated at a maximum output power not listed above, the recommended separation distance d in meters(m)can be estimated using the equation applicable to the frequency of the transmitter, where P is the maximum output power rating of the transmitter in watts(W)according to the transmitter manufacturer.

**NOTE:** At 80 MHz and 800 MHz, the separation distance for the higher frequency range applies.

**NOTE:** The guidelines may not apply in all situations. Electromagnetic propagation is affected by absorption and reflection from structures, objects, and people.



# OMRON PRODUCT WARRANTY

1. Warranty on the device purchased at OMRON is valid for one year.
2. We will not provide free warranty service for failures caused by the personal reasons.  
For example:
  - a) Failure caused by unauthorized disassembly or modification of the product;
  - b) Unauthorized transportation of the product to another place, failure or damage caused during transportation;
  - c) Failure caused by accidental fall during use or handling;
  - d) Failure caused by lack of reasonable maintenance;
  - e) Failure caused by wrong behavior which is not based on instruction manual;
  - f) Failure caused by improper repair by a repair shop not authorized by Omron, etc.
3. The maintenance service outside the warranty scope will be charged according to the regulations (door-to-door fee, replacement parts fee, etc.).
4. When requesting warranty service, please contact the customer support for consultation.
5. When performing warranty service, if necessary, we can request qualified technicians identified by us to provide product circuit diagrams and repairable component data.
6. Guarantee that repair parts will continue to be provided within five years after the product is discontinued.

Customer support

Tel: **1800-419-0492**

Working Hours

**Monday-Friday 9am-5:30pm.**

Closed on Saturdays, Sundays and Public Holidays.

Customer support

Email: **callcentre@omron.com**

To know more about our authorised service centres for Oxygen concentrators please visit support section at our Website

https: **www.omronhealthcare-ap.com/in**

<b>Manufacturer</b> 	<b>OMRON HEALTHCARE Co., Ltd.</b> 53, Kunotsubo, Terado-cho, Muko, KYOTO, 617-0002 JAPAN
<b>Production facility</b>	<b>Hefei Medris Medical Technology Co., Ltd.</b> The first and second floor, No. 2 Plant of Lianda Optoelectronics, 100 meters south of the intersection of Xianghongdian Road and Changning Avenue, High-tech Zone, Hefei City, Anhui Province, CHINA

Last revision date: January 2022

Made in China

PIM: 3294370-0A

5.06.006-1(A0)